

SureSmile® Patient Kit Wear and Care Guide

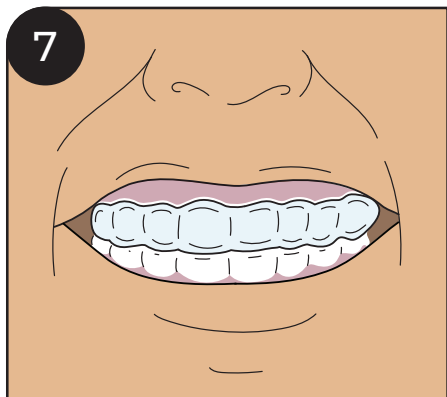

SureSmile® Patient Kit Wear and Care Guide

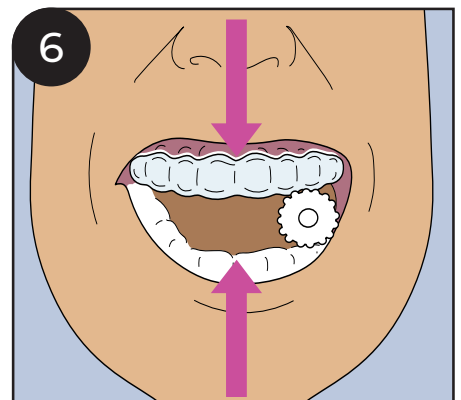
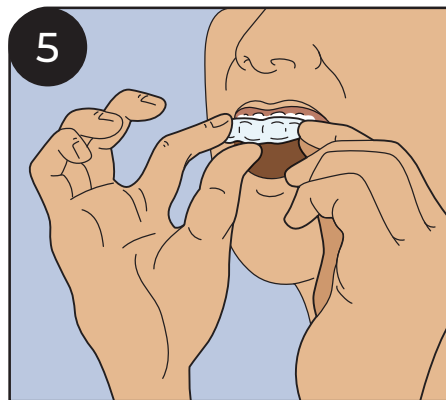
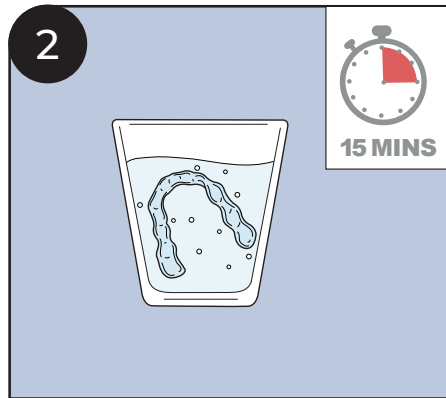
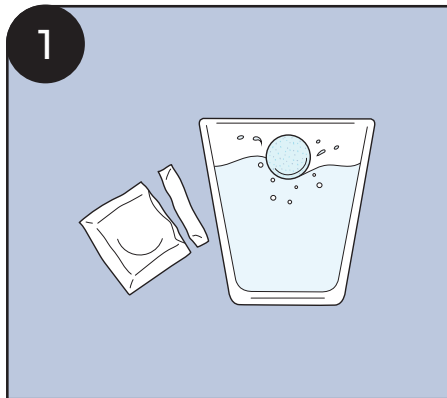
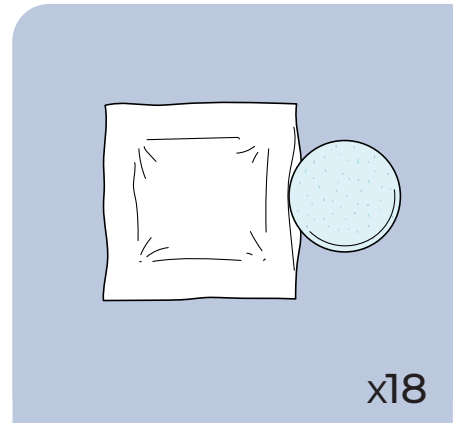
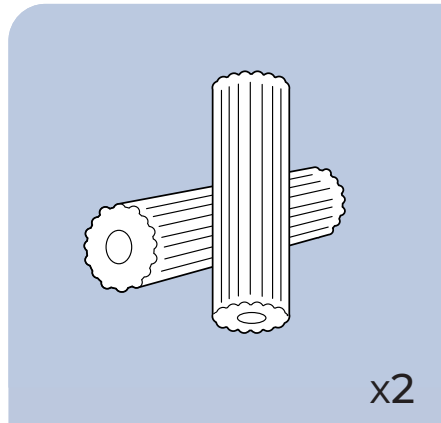
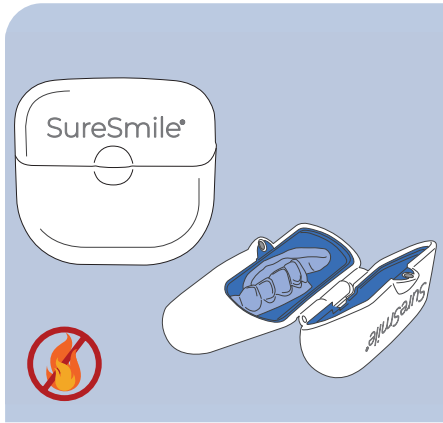